

Contact insert M23 Signal - 7-pole (solder)

Item number 7001907104

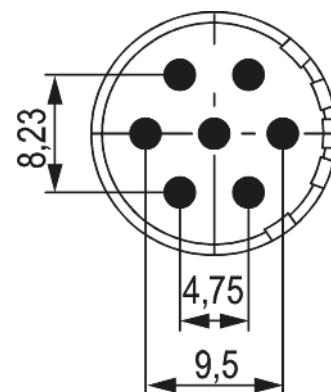
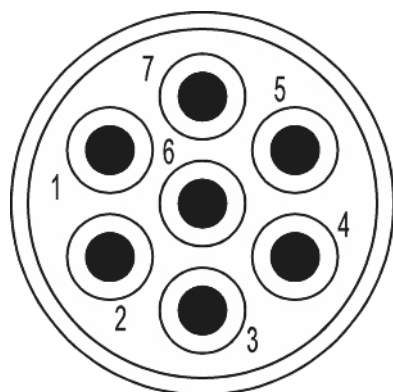

Technical data

Characteristic of connection	Solder
Number of poles	7
Pole picture	7
	Pinout clockwise
Insert	Socket
Color contact insert	white
Material insulating body	PA 6 , PBT
Number of contacts signal	7
Contact-Ø signal	2 mm
Nominal current signal	20 A
Nominal voltage at degree of pollution 3 signal	300 V~
Test voltage signal	840 V~
Insulation resistance signal	> 10 ⁸
max. contact resistance signal	3 mOhm
Temperature range	-40°C to +125°C



Contact insert M23 Signal - 7-pole (solder)

Item number 7001907104

Degree of Protection	3
Flammability	V-0 (UL 94)



Contact insert M23 Signal - 7-pole (solder)

Item number 7001907104

Commercial data

Packaging Unit	25
EAN code	4033878500323
Weight	0.00246 kg
ETIM 7	EC003557
ETIM 8	EC003557
ETIM 9	EC003557
eCl@ss 10.1	27440223
Customs tariff number	85369010

Note:

